

Description : Flat Lithium Battery
Chemical system : Lithium Manganese Dioxide
Nominal voltage : 3 Volts
Nominal capacity : 590mAh
Dimensions : Ø24.5mm x 5.0mm
Shelf life : 10 years at room temperature
Average weight : 6.6 grams
Temperature range : -20°C ~ 60°C

Cross References:

IEC	JIS	Panasonic	Varta
CR2450	CR2450	CR2450	CR2450

Discharge Characteristics

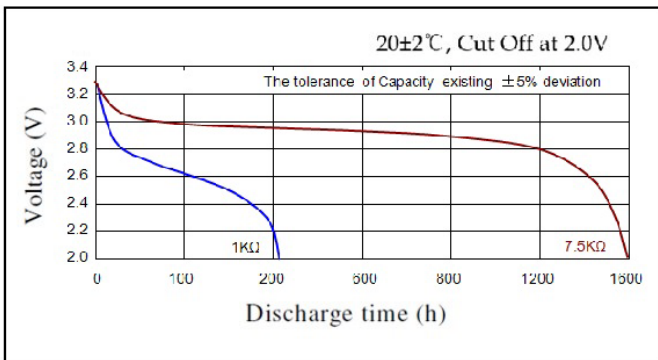

Pulse discharge characteristics

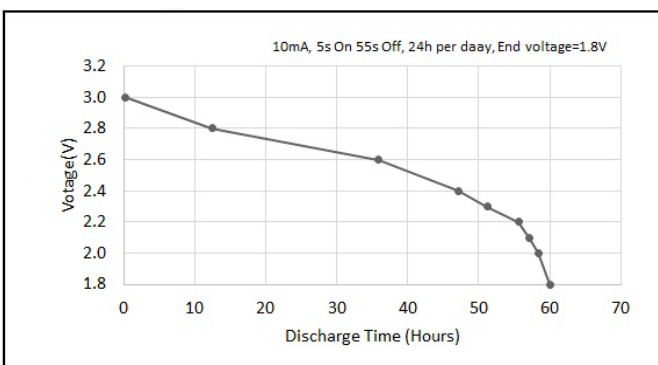

Model No.: **CR2450**

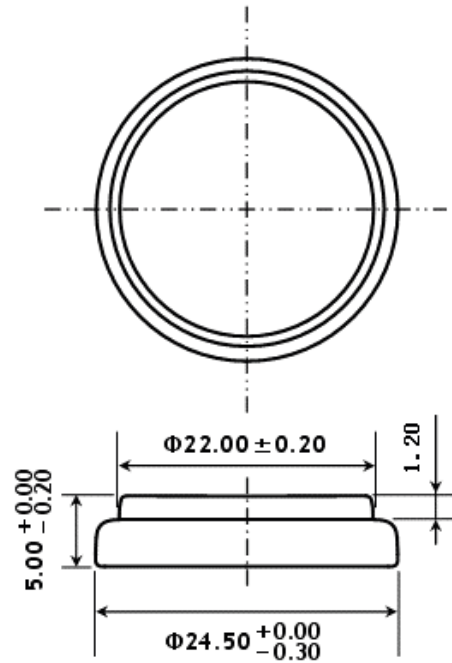

Dimension Drawing

The information (subject to change without prior notice) contained in this document is for reference only and should not be used as a basis for product guarantee or warranty. For applications other than those described here, please consult your nearest GP Sales and Marketing Office or Distributors.